



MADE IN
SYNCO

SORPRESA *SURPRISE*

Trova il giusto supporto nella nostra ampia gamma, per un punto vendita dinamico e sorprendente.

Find the right support in our range for a point of sale which is dynamic and surprising.

EVIDENZIATORI PROMOZIONALI e di category/brand

PROMOTION & category/brand talkers



pag

- 136** Promostop estrusi basculanti
Extruded flip-up shelf talkers



- 137** Promostop per profili scanner portaprezzi
Shelf talkers for scanner rails / datastrips



- 138** Porta stop a bandiera attacco ai profili scanner portaprezzi
Flag stoppers fixing onto scanner rails / datastrips

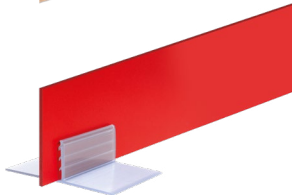

- 139** Supporti per comunicazioni
Sign holders



- 141** Bandierine e clips a chiocciola
Flags and snail clips



- 142** Porta banner SWING basculante magnetico
SWING pivoting magnetic aisle sign fixture



- 143** Porta banner SHOCK ABSORBER magnetico
SHOCK ABSORBER magnetic aisle sign fixture



- 144** Porta banner vari
Aisle sign fixtures



- 146** Porta banner per cielini su scaffali/banchi frigo
Aisle sign fixtures for ceilings for shelvings/coolers



- 147** Banner personalizzati e accessori
Custom made aisle signs and accessories

Promostop estrusi basculanti

Extruded flip-up shelf talkers



Trasparenza ed economicità unite in un unico prodotto.
Transparency and cost-effectiveness all in one product.

1

Profilo basculante a pinza per profili scanner - inserimento messaggio posteriore
Flip-up clamp profile for scanner rails - side rear message insertion

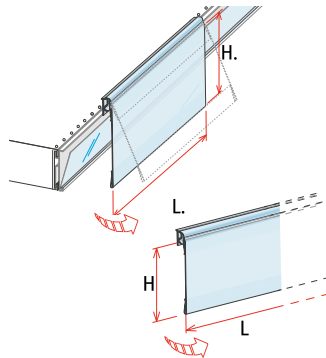

	INSERTO / Ticket size		CODE	PACK
	L.	H.		
	mm	mm		pcs/box
PORTA ETICHETTE SINGOLE / Single ESL holder				
A7	105	74	DSESB075TR0105	600
A7	74	105	DSESB105TR075	600
A6	148	105	DSESB105TR0150	350
PROFILO IN BARRA / Profile for ESL				
Special size		74	DSESB075TR_	== M2
		105	DSESB105TR_	== M2



ATTACCHI PER REALIZZAZIONI SPECIALI (con adesivo) - utilizzabili anche per applicazione a prodotti **nr. 10**
Fixings for custom products (with tape) - also suitable to stick to items **nr. 10**

2

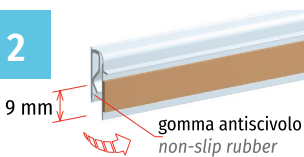

Supporto per profili scanner.
Support for scanner profile.

Transparent DS19800TR

3

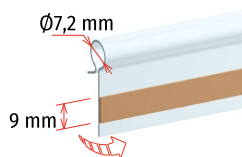

Supporto per filo metallico.
Support for wire.

Transparent LHH50BARTR

4

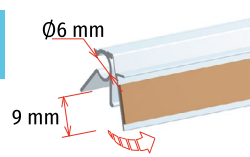

Supporto per filo metallico Ø6 mm.
Support for wire Ø6 mm.

Transparent DS13200TR

5

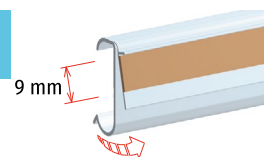

Per cursore stondato COSTAN.
For COSTAN rounded edge shelf.

Transparent DS15000

6

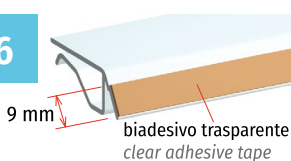

Per ripiani di spessore da 3 a 10 mm.
For shelves thickness from 3 to 10 mm.

Transparent DS18600TR

7



Per ripiani di spessore da 3 a 10 mm.
For shelves thickness from 3 to 10 mm.

Transparent DS17400TR

8

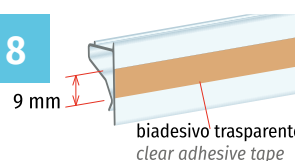

Per spessori da 3 a 10 mm.
For thickness from 3 to 10 mm.

Transparent DS17600TR

9

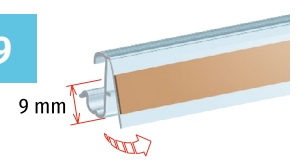

Per ripiani Cefla System10 o doppio filo.
For shelves Cefla System10 or double wire.

Transparent DS10400TR

LEGENDA

: Basculante / Flip-up

P3 : Minimo ordine / Minimum order : 3.000 pcs

M2 : Minimo ordine / Minimum order : 2.000 m

Promostop per profili scanner

Shelf talkers for scanner rails



La produzione con macchine automatiche alimentate a energia solare garantisce una qualità costante del prodotto.

Solar powered automatic machineries guarantee constant product quality.



SOLAR ENERGY USED



Sistema STOP-IN per una migliore tenuta

STOP-IN System for a better grip

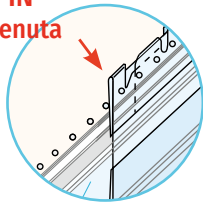

FISSI / FIXED

BASCULANTE / FLIP-UP

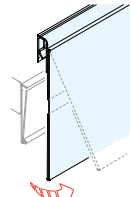
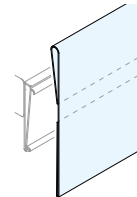
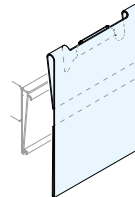

10

Neutri e stampati

Plain and printed

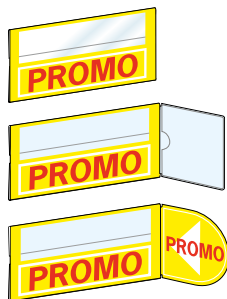
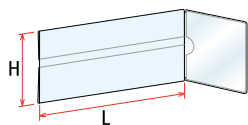
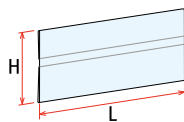

INSERTO Ticket size	STOP-IN	SEMPLICE Simple	PER PROFILI SCANNER FOR SCANNER RAILS
mm	code	code	code
PROMOSTOP NEUTRI / PLAIN SHELF TALKERS			
PROMOSTOP NEUTRI SEMPLICI / Transparent simple shelf talkers			
150 x H. 80	261033	261029	261109
180 x H. 80	261032	261028	261108
Speciale / Special	261062	261064	261110
PROMOSTOP NEUTRI A BANDIERA / Transparent shelf talkers with flag pocket			
80 x H. 80	261184	261182	261188
+ busta / pocket 80 x H. 80			
110 x H. 80	261185	261183	261189
+ busta / pocket 80 x H. 80			
150 x H. 80	261037	261031	261113
+ busta / pocket 80 x H. 80			
Speciale / Special	261068	261034	261114
PROMOSTOP STAMPATI / PRINTED SHELF TALKERS			
PROMOSTOP STAMPATI SEMPLICI / Printed simple shelf talkers			
Escuzione speciale Custom made	261060	261066	261116
PROMOSTOP STAMPATI CON TASCA A BANDIERA / Printed shelf talkers with flag pocket			
Escuzione speciale Custom made	261070	261058	261120
PROMOSTOP STAMPATI A BANDIERA / Printed shelf talkers with flag			
Escuzione speciale Custom made	261042	261038	261118

PROMOSTOP PER GANCI

Shelf talkers for hooks

11

Promostop personalizzato (con o senza laterale)

Personalised shelf talker (with or without flag)

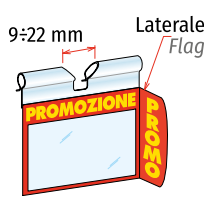

Promostop per ganci personalizzato con taglio centrale universale (senza taglio su richiesta).

Personalised shelf talker for hooks with universal central cut (without central cut, on request).

	Ø	CODE
Frontale / Frontal		LHH51922PRSPS P3
Con laterale / With flag	7 mm	LHH52922PRSPS P3

12

Promostop personalizzato multifunzione

Multifunctional personalised shelf talker



Utilizzabile in 3 modi: su profilo scanner, su singolo portaprezzo a scaffale e su portaetichette per ganci.

Usable in 3 ways: on scanner rail, on single ticket on shelf and on label holder on hooks.

	CODE
Su misura Custom made	261099ST P3

Porta stop a bandiera attacco ai profili portaprezzo

Flag stoppers fixing onto scanner rails

13 Clip gripper per ripiano

Gripper clip for shelves

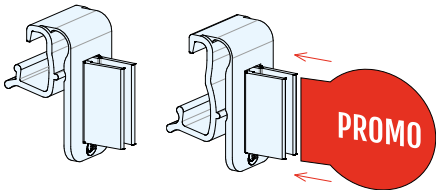

PER RIPIANI / For shelves	CODE	pcs/box
Cefla System10, Wireplus, Wanzl	262C10	100
Cefla System25, Modern Expo	262C25	

14 Gripper per profilo scanner

Gripper clip for scanner rail

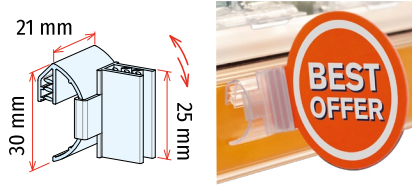

Con angolo regolabile. / Adjustable angle.

PER PROFILI / For scanner rails	CODE	pcs/box
H.min 30 mm	797200	100

15 Gripper per profilo scanner

Gripper clip for scanner rail

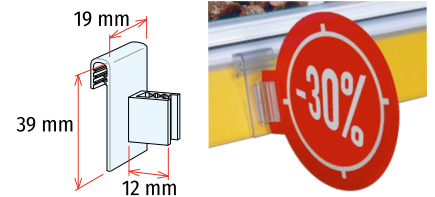

Clip fissa. / Fixed clip.

PER PROFILI / For scanner rails	CODE	pcs/box
H.min 40 mm	797193	100

16 Clip per cursori scanner

Clip for scanner rail

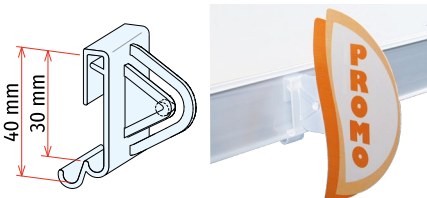

Per inserti con foro. / For cardboard or PVC with hole.

PER PROFILI / For scanner rails	CODE	pcs/box
H. 32/40 mm	262012	100

17 Clip per cursori scanner

Clip for scanner rail

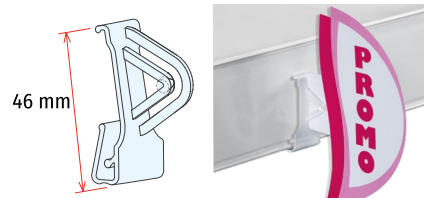

Per inserti con foro. / For cardboard or PVC with hole.

PER PROFILI / For scanner rails	CODE	pcs/box
H.min 50 mm	262011	100

18 Porta stop per cursori scanner

Flag stopper for scanner rail



Per inserti con foro. / For cardboard or PVC with hole.

PER PROFILI / For scanner rails	CODE	pcs/box
H. 30/40 mm	262010	100

19 Inserto in PVC o cartone

Cardboard or PVC flag



Forma o materiale a richiesta. / Shape or material on request.

PER PRODOTTI / For items	CODE	pcs/box
13-14-15 (senza foro/without hole)	240138SF	100
16-17-18 (con foro/with hole)	240138	

20 Busta trasparente

Transparent pocket

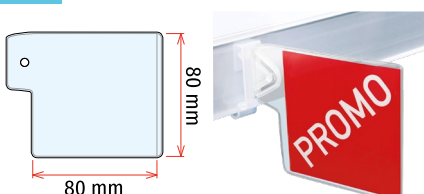

Per inserto intercambiabile. / For changeable message.

PER PRODOTTI / For items	CODE	pcs/box
16 - 17 - 18	240120	100
A richiesta / On request	240139	

21 Clip per cursori scanner

Clip for scanner rail



Per prodotti nr. 22, 23 e 24 / For items nr. 22, 23 and 24

COLOR	CODE	pcs/box
Transparent	262002	100
Bianco / White	262003	

22 Busta trasparente

Transparent pocket

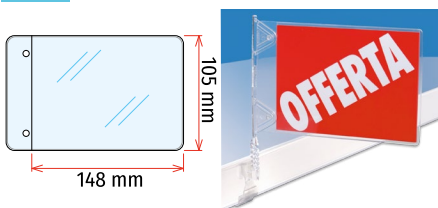

Per prodotto nr. 21. / For item nr. 21.

INSERT	MATERIAL	CODE	pcs/box
A6 (148xH.105 mm)	PVC	240102	100
A richiesta / On request		240109	

23 Inserto "OFFERTA"

"OFFERTA" flag

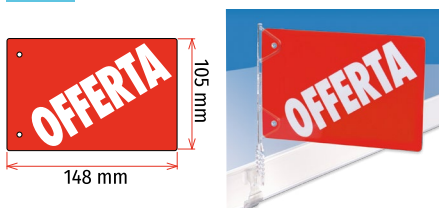

Per prodotto nr. 21. / For item nr. 21.

INSERT	MATERIAL	CODE	pcs/box
A6 (148xH.105 mm)	PVC	743098	100

24 Inserto su misura

Custom made flag



Per prodotto nr. 21. / For item nr. 21.

CODE	
Esec. speciale / Custom made	743099DU

Supporti per comunicazioni

Sign holders

25 Twister in alluminio

Aluminium twister

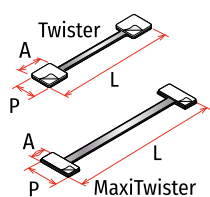

Pieghevole, con 2 adesivi. / Foldable with 2 adhesives.

L	A	P	CODE	pcs/box
75 mm	12 mm	13 mm	792571	100
150 mm	10 mm	20 mm	792576	

26 Megatwister in alluminio

Aluminium Megatwister

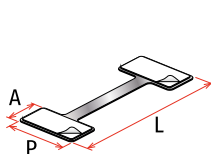

Pieghevole, con 2 adesivi. / Foldable with 2 adhesives.

L	A	P	CODE	pcs/box
75 mm	15 mm	30 mm	792574	100

27 Porta stopper oscillante

Frontal wobbler

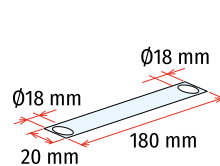

Stampato a richiesta. / Printed on request.

Dimensioni / Sizes	CODE	pcs/box
180x20 mm	170017	100
Su misura / Custom made	170017SP	

28 Gripper adesivo a "T" base 13mm

Adhesive "T" gripper 13mm base

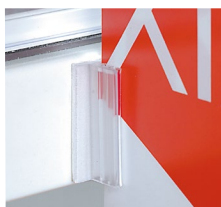
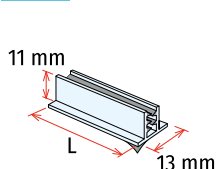

L	Per spessori/Thickness	CODE	pcs/box
25 mm	fino a / up to 2 mm	797147	100
76 mm		797148	

29 Gripper adesivo a "T" base 19mm

Adhesive "T" gripper 19mm base

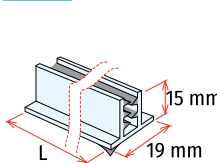

L	Per spessori/Thickness	CODE	pcs/box
25 mm	da / from 3 a / to 4 mm	797126	100
76 mm		797127	

30 Gripper adesivo a "T" base 44mm

Adhesive "T" gripper 44mm base

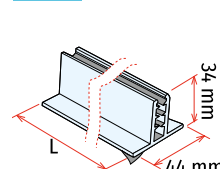

L	Per spessori/Thickness	CODE	pcs/box
76 mm	da / from 3 a / to 6 mm	797145	40

31 Gripper a "T" base 100mm

"T" gripper 100mm base

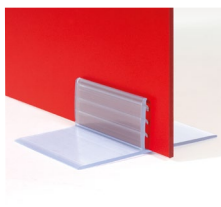
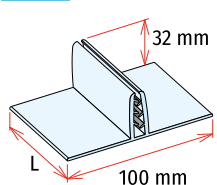

L	Per spessori/Thickness	CODE
74 mm	da / from 3 a / to 5 mm	79714910075

32 Gripper adesivo a "T" basculante

Adhesive "T" swinging gripper

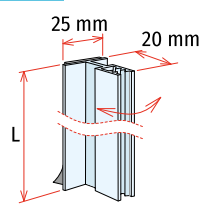

L	Per spessori/Thickness	CODE	pcs/box
25 mm	fino a / up to 1,6 mm	797168	100
75 mm		797169	

33 Gripper adesivo a "T" basculante

Adhesive "T" swinging gripper

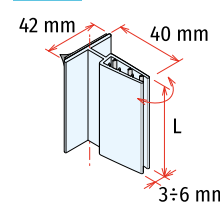

L	Per spessori/Thickness	CODE	pcs/box
75 mm	da / from 3 a / to 6 mm	797172	50

34 Gripper con ventosa

Gripper with suction cup

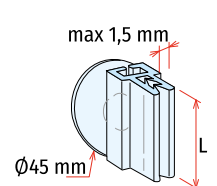

L	Per spessori/Thickness	CODE	pcs/box
45 mm	fino a / up to 1,5 mm	797120	100

35 Calamita tonda Ø48mm

Round magnet Ø48mm

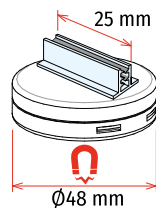

Per spessori/Thickness	CODE	pcs/box
fino a / up to 2 mm	715004	10

36 Clip metallo con magnete

Metal clip with magnet

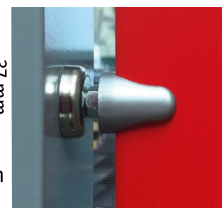
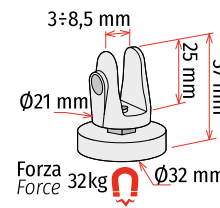

Per spessori/Thickness	CODE	pcs/box
da / from 3 a / to 8,5 mm	772204	10

Supporti per comunicazioni

Sign holders

37 Base tonda con porta messaggio ELITE

ELITE message holder with round base

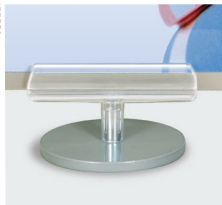
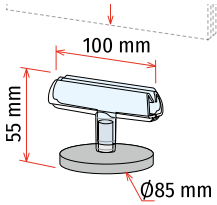

Base tonda in acciaio verniciata grigio RAL9006 con supporto a pinza trasparente.

Round base epoxy painted grey RAL9006 with transparent clamp support.

Per spessori / Thickness	CODE	pcs/box
da/from 1 a/to 5 mm	842257	10

38 Base magnetica con porta messaggio ELITE

ELITE message holder with magnetic base

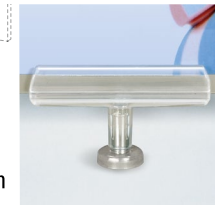
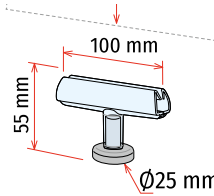

Supporto a pinza trasparente con base magnetica tonda forza 13 kg.

Round magnetic base force 13 Kg with transparent clamp support.

Per spessori / Thickness	CODE	pcs/box
da/from 1 a/to 5 mm	772157	10

39 Gripper di giunzione ad "H"

"H" junction gripper

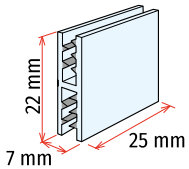

Per spessori / Thickness	CODE	pcs/box
fino a/up to 1,6 mm	797153	100

40 Gripper a pinza con adesivo

Frontal gripper with tape

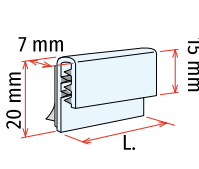

Con adesivo schiuma. / With foam tape.

L.	Per spessori / Thickness	CODE
25 mm	fino a/up to 1,6 mm	797108
76 mm	fino a/up to 1,6 mm	797109
25 mm	da/from 6 a/to 3 mm	797112

41 Gripper adesivo a "L"

Adhesive "L" gripper

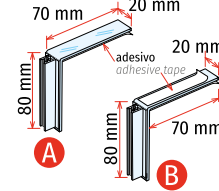

Con adesivo trasparente. / With transparent tape.

Pos.	Per spessori / Thickness	CODE
A	fino a/up to 1,6 mm	744148U
B	fino a/up to 1,6 mm	744148T P01
	Su misura/Custom made	744099

42 Gripper per filo - 2 ganci

Gripper for wire - 2 hooks

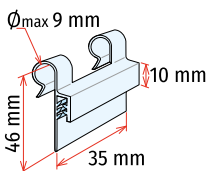

Gripper a 2 ganci. / Gripper with 2 hooks.

Per spessori / Thickness	CODE	pcs/box
fino a/up to 1,5 mm	797182	100

43 Gripper per filo - 1 gancio

Gripper for wire - 1 hook



Gripper a gancio singolo. / Gripper with single hook.

Per spessori / Thickness	CODE	pcs/box
fino a/up to 2 mm	797180	20

44 Banda per profilo

Strip for datastrips



	CODE
Tinta unita / Plain color	DS210SPSZ
Personalizzata / Personalised	152000 P01

45 Supporto category a "L"

"L" support for category

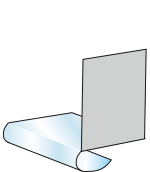

Con adesivo per prodotto n. 46 / With tape for item nr. 46

CODE
797108SP3526

46 Profilo per category

Category profile

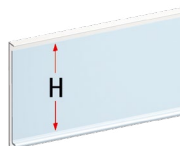

I profili sono facili da sezionare in modo da rendere l'operatore indipendente. Da utilizzare con prodotto nr. 45. Altre lunghezze a richiesta.

The profiles can be easily cut by the operator. To use with item nr. 45. Other lengths on request.

H	L.	CODE
26 mm		DS00626WH1330BF
32 mm	1330 mm	Bianco / White DS00632WH1330BF
40 mm		DS00640WH1330BF

LEGENDA

P01 : Minimo ordine / Minimum order : 100 pcs

Bandierine e clips a chiocciola

Flags and snail clips

47

Supporto diritto adesivo per tubo Ø7mm
Straight adhesive base for tube Ø7mm

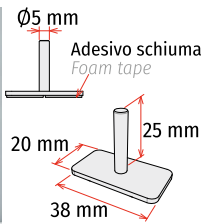

Con adesivo schiuma, si attacca a superfici sia orizzontali che verticali per creare bandiere.
 With foam tape, it sticks to both horizontal and vertical surfaces to create flags.

CODE	
Bianco / White	841302

48

Supporto obliquo adesivo per tubo Ø7mm
Angled adhesive base for tube Ø7mm

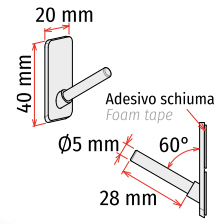

Con adesivo schiuma, si attacca a superfici sia orizzontali che verticali per creare bandiere.
 With foam tape, it sticks to both horizontal and vertical surfaces to create flags.

CODE	
Bianco / White	841304

49

Tubo per bandierina
Tube for flag

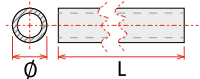

In plastica bianca.
 Altre lunghezze a richiesta.
 In white plastic.
 Other lengths on request.

L.	Ø	CODE
1500 mm	7,0 mm	841312

50

Tubo con fenditura
Tube with slit

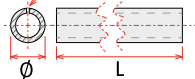

In plastica bianca.
 Altre lunghezze a richiesta.
 In white plastic.
 Other lengths on request.

L.	Ø	CODE
1500 mm	7,0 mm	841312F

51

Tappo interno per tubo
Inner cap for tube

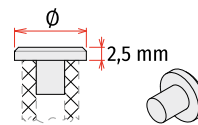

In plastica bianca.
 In white plastic.

Ø	CODE
10 mm	841320



52

Clip a chiocciola con frontale liscio
Snail clip with smooth front

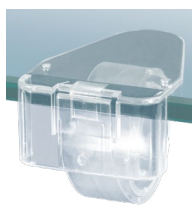
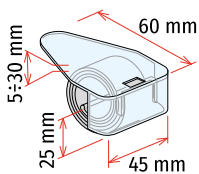

Clip trasparente universale con frontale liscio.
 Transparent universal clip for shelves with smooth front.

Per spessori / Thickness	CODE	pcs/box
da/from 5 a/to 30 mm	Transparent 744008F	20

53

Clip a chiocciola con adesivo
Snail clip with foam tape

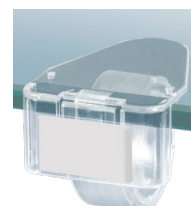
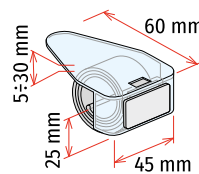

Clip trasparente universale con adesivo schiuma.
 Transparent universal clip for shelves with adhesive foam.

Per spessori / Thickness	CODE	pcs/box
da/from 5 a/to 30 mm	Transparent 744008FAD	20

54

Clip a chiocciola con attacco a slitta 9 mm
Snail clip with guide 9 mm

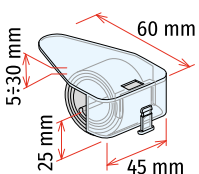

Clip trasparente universale con attacco a slitta 9 mm sul frontale.
 Transparent universal clip for shelves with guide 9 mm.

Per spessori / Thickness	CODE	pcs/box
da/from 5 a/to 30 mm	Transparent 744008TR	20

55

Clip a chiocciola con gripper
Snail clip with gripper

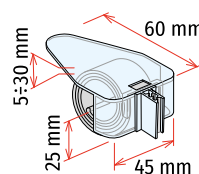

Clip trasparente universale con gripper per sp. fino a 2 mm.
 Clear universal clip for shelves with gripper for thickness up to 2 mm.

Per spessori / Thickness	CODE	pcs/box
da/from 5 a/to 30 mm	Transparent 744008GTR	20



Porta banner SWING basculante magnetico SWING pivoting magnetic aisle sign fixture



Basculante - Pivoting

Se urtato, torna in posizione
If touched it returns to the original position



Angolo regolabile - Adjustable angle

Per ripiani inclinati
For angled shelves



Versatile

Con molte soluzioni
With many solutions

3

Posizioni - Positions

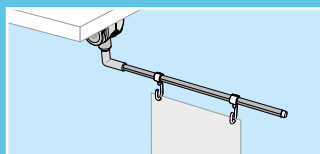

Sotto al ripiano
Under the shelf

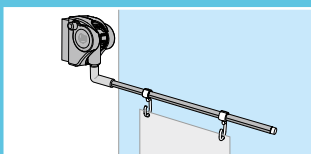

In verticale
On a vertical surface

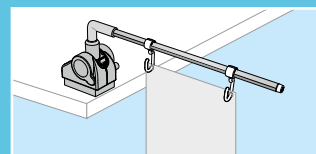

Sopra al ripiano
On the shelf

56

SWING III - basculante magnetico

SWING III - magnetic swinging

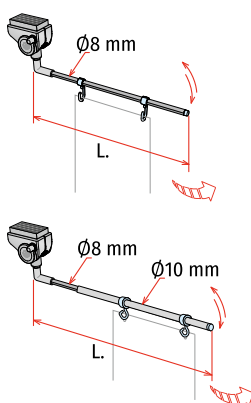

L.	PER PESI fino a	COLOR	CODE	PACK
mm	g			pcs/box
SWING III magnetico / SWING III magnetic				
260	250	Grigio / Grey	841208	10
		Nero / Black	841208BK	
430	120	Grigio / Grey	841211	10
		Esecuzione speciale / Custom made	841299	
SWING III telescopico magnetico / SWING III telescopic magnetic				
250÷420	120		841212	10
		Esecuzione speciale / Custom made	841299	

57

SWING III - con porta stop

SWING III - with flag stopper

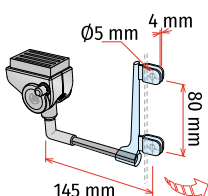

Per incastrare banner, tramite 2 fori, di spessore fino a 4 mm.

To fix a message with 2 holes, thickness up to 4 mm.

PER PESI fino a	CODE	pcs/box
For load up to		
300 g	841208CLIP	10
Esec. spec. / Custom made	841299	P01

58

SWING III - per ripiani in filo

SWING III - for wire shelves

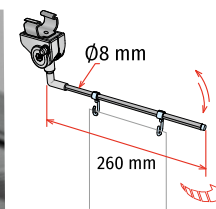

PER PESI fino a	CODE	pcs/box
For load up to		
200 g	841208WR	10
Esecuzione speciale / Custom made	841299	P01

LEGENDA

: Basculante / Flip-up

P01 : Minimo ordine / Minimum order : 100 pcs

Porta banner SHOCK ABSORBER magnetico SHOCK ABSORBER magnetic aisle sign fixture



Shock absorber

Se leggermente urtato, torna in posizione
If slightly touched it returns to the original position

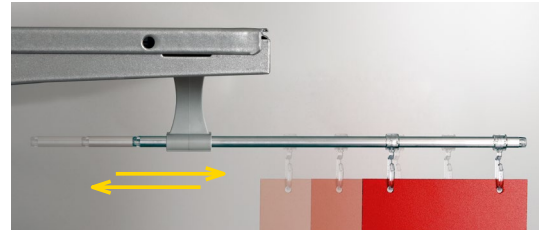

Regolabile - Adjustable

Tubo scorrevole che permette la regolazione desiderata
The sliding tube can be set at the desired position

2

Posizioni - Positions

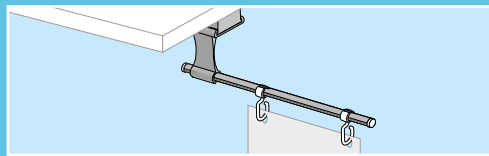

Sotto al ripiano
Under the shelf

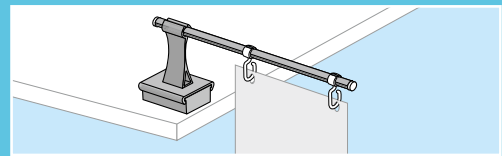

Sopra al ripiano
On the shelf

59

SHOCK ABSORBER - magnetico SHOCK ABSORBER - magnetic

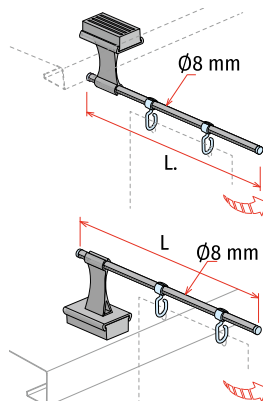

L.	PER PESI fino a For load up to	COLOR	CODE	PACK
mm	g			pcs/box
Attacco sotto il ripiano / Fixing under the shelf				
250	120	Grigio / Grey	841260	10
420	70	Nero / Black	841260BK	
Esecuzione speciale / Custom made			841299	P01
Attacco sopra al ripiano / Fixing on the shelf				
Esecuzione speciale / Custom made			841299SR	10 P01

60

SHOCK ABSORBER - con porta stop SHOCK ABSORBER - with flag stopper

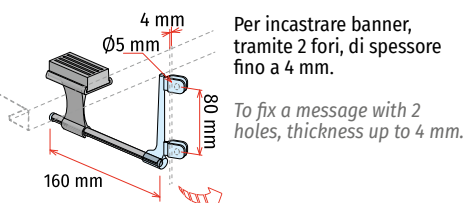

Per incastrare banner, tramite 2 fori, di spessore fino a 4 mm.
To fix a message with 2 holes, thickness up to 4 mm.

PER PESI fino a For load up to	CODE	pcs/box
150 g	841260CLIP	10
Esec. spec. / Custom made	841299	P01

61

Porta banner magnetico - sopra ripiano Magnetic aisle sign fixture - on the shelf

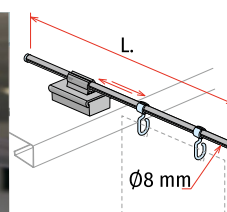

A richiesta per quantità tubo su misura.
On request, on quantities, different length of tube.

L.	PER PESI fino a For load up to	CODE	pcs/box
250 mm	300 g	841250	10
420 mm	130 g	841252	
Esecuzione speciale / Custom made			841299 P01

Porta banner vari

Aisle sign fixtures

62 Porta banner magnetico

Magnetic aisle sign fixture

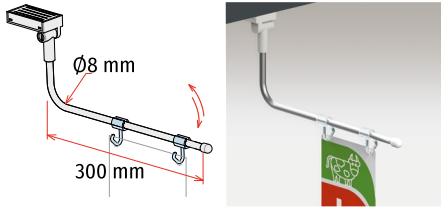

Angolo regolabile. Tubo in alluminio.
Adjustable angle. Aluminium tube.

	CODE	pcs/box
Bianco / White	841207	10

63 Porta banner adesivo

Aisle sign fixture with tape

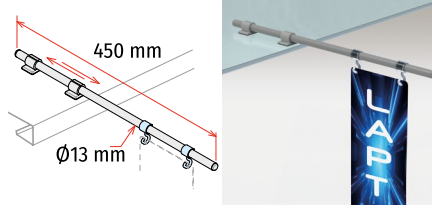

Con adesivo schiuma. Tubo in alluminio.
With foam tape. Aluminium tube.

	CODE	pcs/box
Grigio / Grey	841260AD	10

64 Porta banner a morsetto

Aisle sign fixture with clamp



Morsetto in acciaio. Tubo in alluminio.
Clamp made in steel. Aluminium tube.

Per spessore / Thickness	CODE	pcs/box
fino a / up to 35 mm	8425MOR250	10

65 Telescopico per pannello forato

Telescopic for metal pegboard

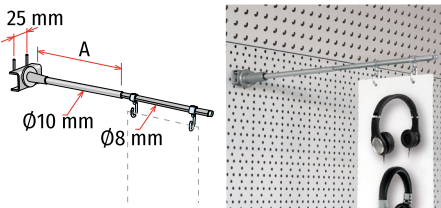

Per pannelli forati passo 25 mm.
Tubo in alluminio.
For pegboard pitch 25 mm.
Aluminium tube.

L.	A	Pesi fino a Load up to	CODE
350÷550 mm	290 mm	170 g	841209
540÷900 mm	480 mm	220 g	841210
Esec. speciale / Custom made			841299 P01

66 Telescopico per montante

Telescopic for shelf upright

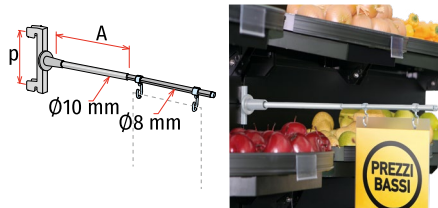

Tubo in alluminio. / Aluminium tube.

L.	A	Passo (p) Pitch (p)	CODE
350÷550 mm	290 mm	25 mm	841239
		36 mm	841243
540÷900 mm	480 mm	25 mm	841241
		36 mm	841245
Esec. speciale / Custom made			841299 P01

67 Telescopico per barra di forza

Telescopic for mounting bar

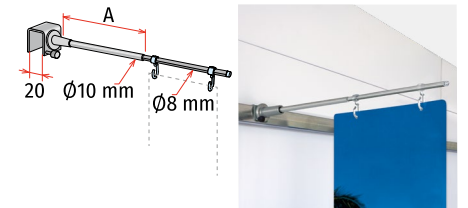

Con vite di regolazione inclinazione e adattabilità anche per spessore di 15 mm. Tubo in alluminio.
With screw to regulate the angle. It fits also the 15 mm thickness. Aluminium tube.

L.	A	CODE
350÷550 mm	290 mm	841229
540÷900 mm	480 mm	841230
Esec. speciale / Custom made		841299 P01

68 Magnetico - con NEMO

Magnetic - with NEMO

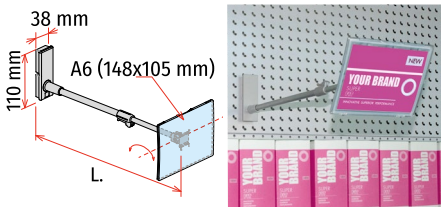

Asta telescopica in alluminio con porta etichette NEMO per inserto A6 orizzontale (148 x H.105 mm).
Con snodo per inclinazione regolabile.

Aluminium telescopic tube with label holder for insert A6 horizontal (148 x H.105 mm).
With hinge for adjusting the inclination.

Estensibile / Extendable	CODE	pcs/box
da/from 480 a/ to 740 mm	841272N	10

69 Magnetico - con busta A5

Magnetic - with A5 pocket

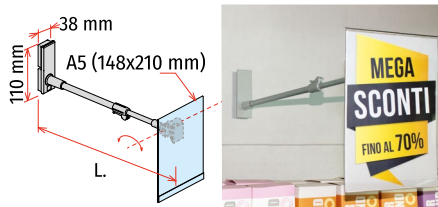

Asta telescopica in alluminio con tasca trasparente per inserto A5 verticale (148 x H.210 mm).
Con snodo per inclinazione regolabile.

Aluminium telescopic tube with clear pocket for insert A5 portrait (148 x H.210 mm).
With hinge for adjusting the inclination.

Estensibile / Extendable	CODE	pcs/box
da/from 550 a/ to 820 mm	841272A5	10

Su richiesta soluzioni "easy" con gripper
On request "easy" solutions with gripper



70

Telescopico magnetico*Telescopic magnetic*

Per barra di forza utilizzare con magneti da 40 kg.
For mounting bar use the 40 kg magnet.

L.	Magnete Magnet	Pesi fino a Load up to	CODE
380÷630 mm	32 kg	170 g	841029
	40 kg	220 g	841040
420÷700 mm	40 kg	170 g	841041
Esec. speciale / Custom made			841299 P01

71

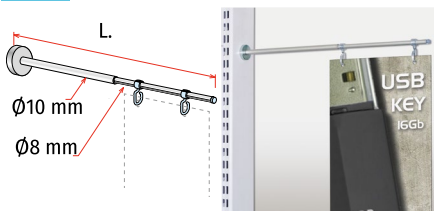
Telescopico magnetico SLIM*Telescopic magnetic SLIM*

Ideale per barra di forza con magneti da 40 kg.
Great for mounting bar with 40 kg magnet.

L.	Magnete Magnet	Pesi fino a Load up to	CODE
320÷560 mm	32 kg	110 g	841060
440÷700 mm	32 kg	100 g	841062
470÷700 mm	40 kg	170 g	841063
Esec. speciale / Custom made			841299 P01

72

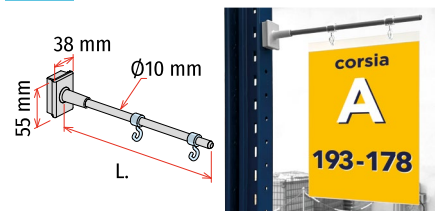
Porta banner magnetico*Magnetic aisle sign fixture*

Asta fissa Ø10 mm in plastica.
Tube Ø10 mm made in plastic.

L.	CODE	pcs/box
250 mm	841286	10
Esec. speciale / Custom made		841299 P01

73

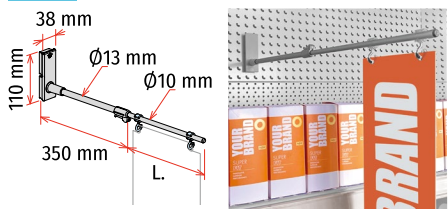
Telescopico - con 2 ganci*Telescopic - with 2 hooks*

Porta banner con base magnetica doppia, tubi in alluminio e ganci in plastica trasparente.
Adatto per attacco allo schienale dello scaffale.

Aisle sign fixture with double magnet, aluminium tubes and clear hooks. Suitable for attachment to the shelving back panel.

L.	CODE	pcs/box
da/from 15 a/to 430 mm	841274	10
Esec. speciale / Custom made		841299 P01

74

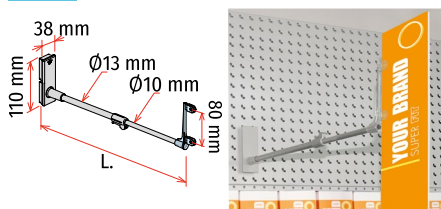
Telescopico - con porta stop*Telescopic - with flagstopper*

Porta stop a 2 fori con base magnetica doppia, tubi in alluminio, per messaggi di spessore fino a 4 mm.
Adatto per attacco allo schienale dello scaffale.

Flag stopper with double magnet for messages with 2 holes (thickness up to 4 mm). Aluminium tubes. Suitable for attachment to the shelving back panel.

Estensibile / Extendable	CODE	pcs/box
da/from 510 a/to 780 mm	841274PG	10
Esec. speciale / Custom made		841299 P01

75

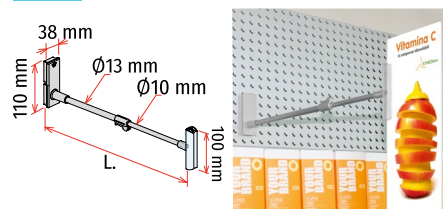
Telescopico - con pinza "ELITE"*Telescopic - with clamp "ELITE"*

Porta banner con base magnetica doppia, tubi in alluminio. Con pinza trasparente "ELITE" per messaggi da 1 a 5 mm.
Adatto per attacco allo schienale dello scaffale.

Aisle sign fixture with double magnet, aluminium tubes. With clear ELITE clamp for thickness from 1 to 5 mm. Suitable for attachment to the shelving back panel.

Estensibile / Extendable	CODE	pcs/box
da/from 510 a/to 780 mm	841274E	10
Esec. speciale / Custom made		841299 P01

FORCHE MAGNETICHE*Magnetic sign holder arms*

76

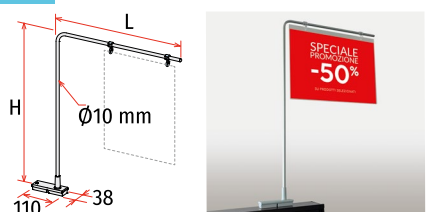
Forca magnetica fissa*Magnetic sign holder arm*

Braccio fisso a "L" con tubo in alluminio Ø10 mm.
Sign holder "L" arm with aluminium tube Ø10 mm.

L x H.	CODE	
420 x H.620 mm	761234	
Esec. speciale / Custom made		761299 P01

77

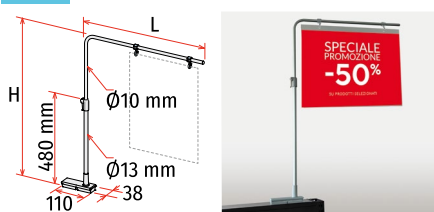
Forca magnetica telescopica*Telescopic sign holder arm*

Braccio a "L", estensibile in altezza. Con tubi in alluminio Ø10/13 mm.
Extendable sign holder "L" arm. Aluminium tubes Ø10/13 mm.

L.	Estensibile / Extendable	CODE
420 mm	H. 480÷690 mm	761236
Esec. speciale / Custom made		761299 P01

78

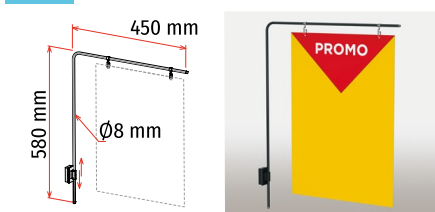
Forca magnetica*Sign holder arm*

Braccio fisso a "L" con tubo in alluminio Ø8 mm. Attacco verticale.
Sign holder "L" arm with aluminium tube Ø8 mm. Vertical attachment.

	CODE	
Nero / Black	761FCPROMMAGBK	
Grigio / Grey	761FCPROMMAGGY	
Esec. speciale / Custom made		761299 P01

LEGENDA

P01 : Minimo ordine / Minimum order : 100 pcs

Banner per ciellini su scaffali/banchi frigo

Aisle sign fixtures for ceilings for shelving/coolers



79 Pannello banner personalizzabile con attacco magnetico

Customisable aisle sign panel with magnetic attachment

Pannello basculante in composito plastico e attacco magnetico.
Flip-up panel made of plastic composite with magnet.

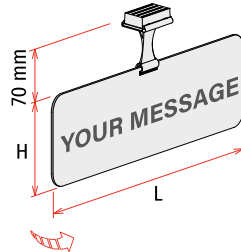

	CODE	PACK
		pcs/box
ATTACCO MAGNETICO / Magnetic attachment		
Grigio / Grey	715MAGGY	20
Nero / Black	715MAGBK	20
BANNER / Sign		
Misura consigliata / <i>Advised size: L. 350 x H. 120 mm</i>		
Esecuzione speciale / <i>Custom made</i>	715MAG99	20 L2



80 Banner personalizzato - foro singolo

Custom made aisle sign - single hole

Su misura e personalizzato secondo le vostre esigenze.
Custom made according to your needs.



	CODE	
Esecuzione speciale / <i>Custom made</i>	232089	L2

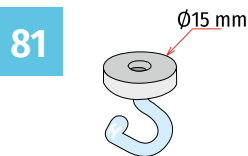

81 Magnete Ø15 mm con gancio trasparente.
Magnet Ø15 mm with transparent hook.

FORZA <i>Force</i>	CODE	PACK
		pcs/box
7 kg	715013	20

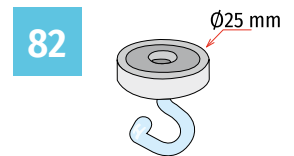

82 Magnete Ø25 mm con gancio trasparente.
Magnet Ø25 mm with transparent hook.

FORZA <i>Force</i>	CODE	PACK
		pcs/box
13 kg	715012	20

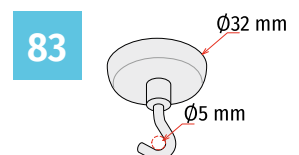

83 Magnete Ø32 mm con gancio.
Magnet Ø32 mm with hook.

FORZA <i>Force</i>	COLOR	CODE	PACK
			pcs/box
8 kg	Bianco / White	715015	20

LEGENDA

: Basculante / *Flip-up*

L2 : Minimo ordine / *Minimum order* : 20 pcs

Banner personalizzati e accessori

Custom made aisle signs and accessories

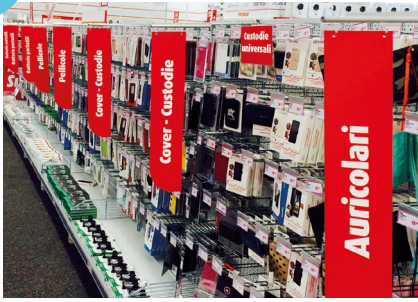

Dividere le categorie di prodotto.
Divide the product categories



Evidenziare offerte o messaggi.
Presentare nuovi prodotti.
To highlight offers or messages.
Introduce new products.

Personalizziamo materiali plastici o cartoncino con stampa digitale, serigrafia e offset

We personalize plastic or cardboard signs with digital, screen printing and offset printing

84



Banner personalizzato e su misura con 2 fori.
Custom made aisle sign with 2 holes.

	CODE
Su misura / Size on request	841089 L2

85

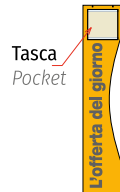

Banner con tasca su misura con 2 fori.
Custom made aisle sign with pocket with 2 holes.

	CODE
Su misura / Size on request	841090 L2

86

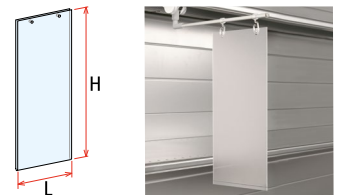

Busta trasparente antiriflesso (spessore 0,4 + 0,4 mm).
Transparent antiglare pocket (0,4 + 0,4 mm thickness).

	L x H.	CODE
A4	210 x H. 297 mm	242204
A3	297 x H. 420 mm	242202
Su misura / Size on request		242219 L2

87



Gancio chiuso trasparente porta banner.
Transparent closed hook for aisle sign fixtures.

Per tubi Ø / For tubes Ø	CODE	PACK
8 mm	915694	20 pcs/box

88

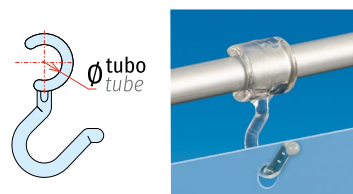

Gancio aperto trasparente porta banner.
Transparent open hook for aisle sign fixtures.

Per tubi Ø / For tubes Ø	CODE	PACK
10 mm	723000	20 pcs/box
13 mm	723050	

89

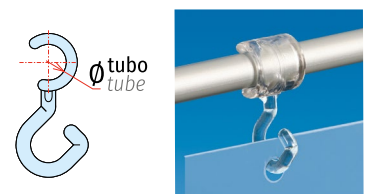

Gancio chiuso trasparente porta banner.
Transparent closed hook for aisle sign fixtures.

Per tubi Ø / For tubes Ø	CODE	PACK
10 mm	723002	20 pcs/box
13 mm	723054	

90

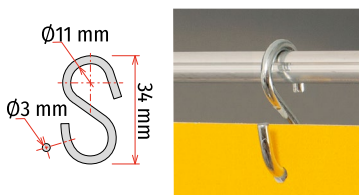

Gancio a "S" metallico porta banner.
Metal "S" shaped hook for aisle sign fixtures.

	CODE	PACK
	721009	20 pcs/box

91

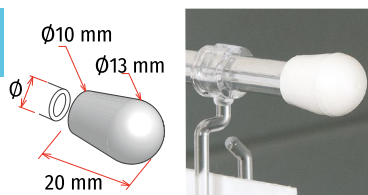

Tappo antinfortunio in gomma bianca.
Safety end cap in white rubber.

Per tubi Ø / For tubes Ø	CODE	PACK
7÷8 mm	680830	50 pcs/box

92

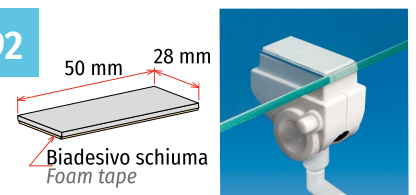

Placca metallica adesiva per superfici non metalliche.
Metallic adhesive plate for non-metallic surfaces.

	CODE	PACK
50 x 28 mm	841PIAS	10 pcs/box